

Attachment

Car power cable	x1
User's Manual	x1
Warranty card	x1
Qualification certificate	x1

Notes:

- 1、 In case of any change in the above specifications in the interest of product improvement, no separate notice shall be issued.
- 2、 Please purchase the filter from designated points of sale.
- 3、 Please refer to the warranty card for after-sales service.
- 4、 The tag number found on the unit serves as the warranty card number and product code at the same time. Please keep this tag number, and prevent it from getting scratched.

Purlife[®]

Car air purifier

User's manual

Model No. driveclear 50



Purlife Company Pte Ltd.
Add. 22 Sin Ming Lane, #07-74
Singapore 573969
Tel:(65) 67020306
Email: info@purlifeco.com
Website:www.purlifeco.com

Contents

Product Features	1
Product Components	1
Installation and Information	2
Operations Manual	4
Filter Replacement	3
Product Care and Maintenance	4
Precautions during Operation	6
Product specifications	6

Thank you for purchasing this PurLife® 3 in 1 Car Air Purifier VS720
Before using this product, please read this user's manual carefully and keep this for future reference.

Product features

Car air purifier key technology

- The display of PM2.5 concentration by the sensor applies to the air purification technology;
- The structural design for an effective sensing method

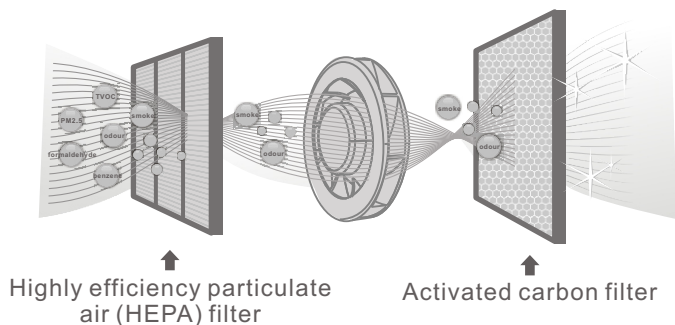

Features

1. Rapidly eliminates germs, fungi, mites, formaldehydes and other toxic and harmful gases, cigarette smoke, pollen, odour and chemical contaminants. Comes with a display of PM2.5 (particle size) concentration level, and effectively eliminates particles of this size.
2. When the unit is plugged in, the car air purifier will automatically operate when the vehicle starts.
3. Comes with smart adjustment features.

Product Components

Unit structural drawing

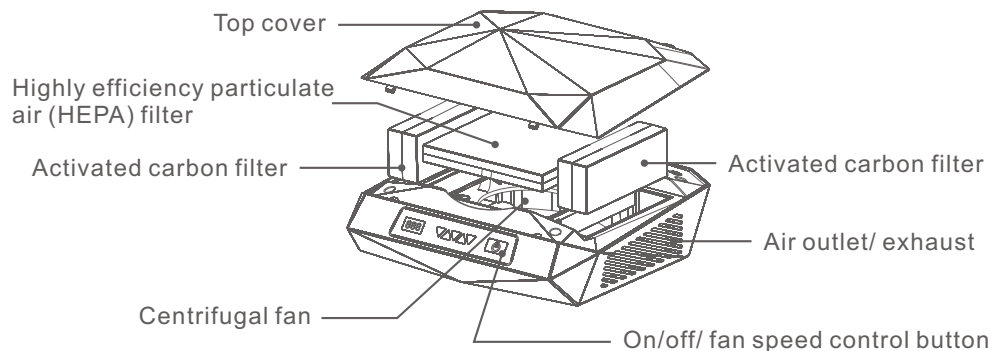

Installation and Information

Location of installation

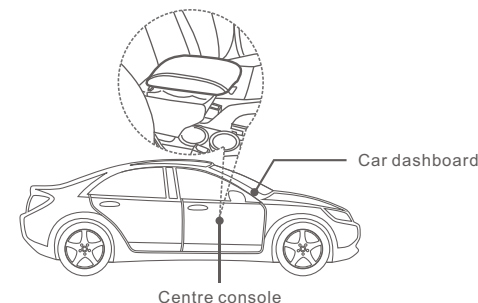

Based on the car model, you may install the car air purifier in various locations within the vehicle, example:

Power connecting cable

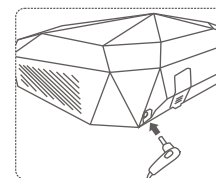

Following the diagram, find the unit's power connector and take out the car power cable; connect one end to the power cable and the other end to the 12V port of the cigarette lighter receptacle.

Steps in disassembling the filter assembly

When using the new unit for the first time, take out the filter assembly from the plastic bag and re-install the filter, ensuring proper installation before connecting to the power source and using the unit. (Note: it is not recommended to turn on the unit before opening the filter's plastic bag. In the process of disassembling the filter, please ensure that the unit is off and the power source is disconnected.)

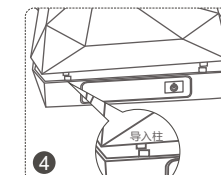
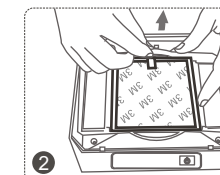
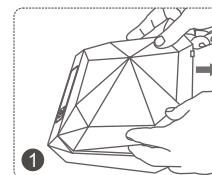

1. Press the two protruded parts at the back of the top cover, then push up before drawing out the top cover from the rear.
2. Take out the activated carbon filter and highly efficiency particulate air (HEPA) filter, then remove the plastic cover.
3. Re-install back the highly efficiency particulate air(HEPA) filter and the activated carbon filter and ensure that the installation is done properly. (Note: When installing, the side with 3M marking must face upward, while the white cloth must be pointed up).
4. Insert the guiding rod in front of the top cover into the slot, then press the cover rear to align it in right position. Ensure that the assembly is properly aligned before fixing the top cover securely.

Operating Manual

Operating the control panel

Operations indicator

Power source/ level control button

Digital tube for displaying PM2.5 concentration level :
The digital tube will show "U57" when the unit is turned on.
After 3-5 seconds, it will show the dust concentration level; when the level is adjusted, the digital tube will show the corresponding description, like "1" for automatic, "2" for medium speed, "3" for high speed, then it will return to indicate the dust concentration level after 3-5 seconds.

Operating Manual

Turning on (Turning off the unit)

1. After the car air purifier's power source is properly connected, the unit will operate automatically when the vehicle starts. Press the power button continuously to turn off, and the unit will be on standby mode.

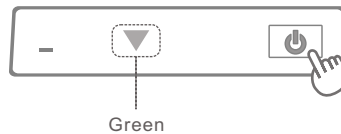

Automatic adjustment

2. Under the automatic operating state, when the environment is polluted and the digital tube shows "--=", the leftmost indicator will turn from green to orange, and the operation will turn to medium speed.
3. Under the automatic operating condition, when the environment is heavily polluted and the digital tube shows "--==", the leftmost indicator will turn from orange to red, and the operation will turn to high speed.

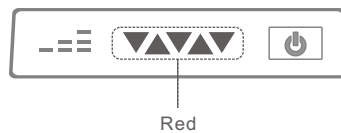
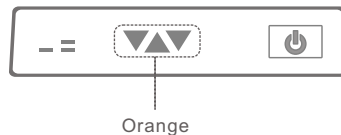

Manual adjustment

5. In the condition of automatic operation, can be manually adjusted for medium speed running or high gear.
在自动档运行状态下,可手动调节为中速档运行或高速档运行.



Filter Replacement Reminder for filter expiry

1. After the filter has exceeded 200 hours of use, all the indicators will light up in orange colour to remind the user that the filter has reached its useful life span and needs to be replaced to ensure optimum performance.



Resetting the filter

2. Under standby mode, press the on/off switch continuously for 8-10 seconds to reset the filter timer. Wait until all indicators light up for 2-3 seconds (showing orange colour) and subsequently dim out, as this would be the signal that the resetting is complete.

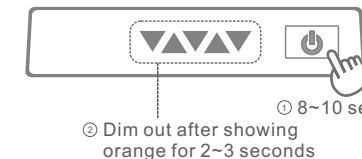

Product care and maintenance

It is recommended to perform cleaning and maintenance of the unit every 2-3 months.

Cleaning the dust sensor

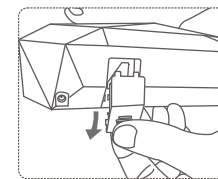

1. Remove the dust sensor cover.

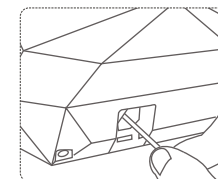

2. Use dry cotton bud to clean the dust sensor's lens.

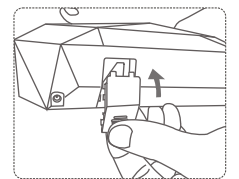

3. Close back the dust sensor cover

Cleaning the unit and the filter

1. Use dry cloth to wipe and clean the exterior casing. Do not use excessive force in wiping, and do not use hot water and cleaning agent and other materials that might harm the surface. Maintain the dryness of the unit, and prevent water to get into the unit.

2. Clean and install the filter on its location.

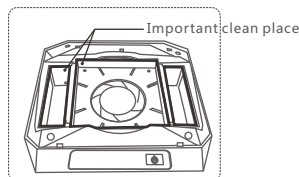

3. Do not wash the filter with water. If there is too much dust after cleaning with vacuum cleaner, use soft-bristled brush to clean.

Types of failure and the methods of addressing them

The unit does not turn on	Check if the power source is properly connected to the unit and to the source.
Unable to eliminate dust and odour	Clean the highly efficiency particulate air (HEPA) filter and the dust sensor. The dust sensor might be experiencing interference from mobile phones and other radio equipment. Do not use mobile phones or other radio equipment beside the unit.
The air is not clean, but the air quality indicator still shows green light	Units that are new or have been off for more than a week have slower dust sensors. Normal operation will only resume after one hour of operation. Turn off the unit for 10 seconds before turning on again. Clean the dust sensor window.
The air is clean, but the air quality indicator still shows orange or red light	The highly efficiency particulate air (HEPA) filter and the dust sensor are dirty or obstructed, please clean the highly efficiency particulate air (HEPA) filter and the dust sensor.

Precautions during operation

Warning

- Do not open up or repair this purifier on your own, please let a professional perform the maintenance and repair work
- Do not operate with wet hands, as this might cause electric shock
- Before replacing the filter, cleaning or moving this purifier, please turn off the unit and unplug the power source
- Use soft cloth in wiping
- For your safety, do not manipulate the air purifier while driving.

Note

- The car air purifier uses precision components, please use them properly and avoid dropping or damaging.
- Do not use liquid to clean or pour on the purifier. These liquids include water, cleaning agents or flammable solutions
- Do not place the unit on an unsteady location or near safety airbags and areas that might affect driving. Neither should it be placed in areas of safety and protection devices nor other locations that might cause obstruction
- Avoid using under humid environment
- Do not place near heat sources or areas with flammable and explosive items
- Do not place the unit under direct sunlight or high temperature for an extended period

IMPORTANT

- Do not twist or squeeze the power cable or place heavy objects on it
- Do not let children play with it.
- Only the specific filter can be used with this car air purifier. Do not use other brands of filter.

In case any of the following occurs, please stop the unit's operation immediately and request for maintenance work

- Abnormal noise or smell
- The unit's external casing is damaged
- A foreign object has gotten into the unit
- The electrical plug or power cable is damaged
- The unit cannot be operated normally
- The power cable overheats

Product Specifications

Model No.: KJ14F-A720(PurLife® 3 in 1 Car Air Purifier VS720)

Rated Voltage: 12V DC

Power Consumption (Power) :	Fan Speed	Power (W)
	Automatic	4W
	Medium Speed	5W
	High Speed	<6.5W

Dimensions :Length 200cm*Width 186cm*Height75cm

Length of the power cable :2m

Applicable space:3~4 cubic meter